



Q-Tech

Q-Tech Commercial Series

QTA 6060M/6130M

Mixer Amplifiers

User Manual

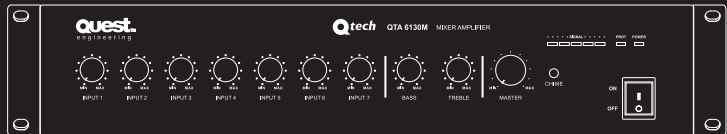

Contents

Safety Precautions	1
General Description	4
Features	4
Front Panel Layout	5
Rear Panel Layout	6
Connections	10
Applications	11
Block Diagram	14
Specifications	15
Dimensional Diagram	16
Technical Notes	17

Safety Precautions

- Be sure to read the instructions in this section carefully before use.
- Make sure you observe the instructions in this manual as the conventions of safety symbols and messages are very important.
- We also recommend you keep this instruction manual handy for future reference.

Safety Symbol and Message Conventions

Safety symbols described below are used in this manual to prevent bodily injury and property damage which could result from mishandling. Before operating your product, read this manual first and understand the safety symbols and messages so you are thoroughly aware of any risks.



WARNING

Indicates a potentially hazardous situation which, if mishandled, could result in death or serious personal injury.



CAUTION

Indicates a potentially hazardous situation which, if mishandled, could result in moderate or minor personal injury, and/or property damage.



WARNING

When Installing the Unit

- Do not expose the unit to rain or an environment where it may be splashed by water or other liquids, as doing so may result in fire or electric shock.
- Use the unit only with the voltage specified on the unit. Using a voltage higher than that which is specified may result in fire or electric shock.
- Do not cut, kink, otherwise damage nor modify the power supply cord. In addition, avoid using the power cord in close proximity to heaters, and never place heavy objects -- including the unit itself -- on the power cord, as doing so may result in fire or electric shock.
- Be sure to replace the unit's terminal cover after connection completion. Because high voltage is applied to the speaker terminals, never touch these terminals to avoid electric shock.
- Be sure to ground to the safety ground (earth) terminal to avoid electric shock. Never ground to a gas pipe as a catastrophic disaster may result.
- Avoid installing or mounting the unit in unstable locations, such as on a rickety table or a slanted surface. Doing so may result in the unit falling down, causing personal injury and/or property damage.

When the Unit is in Use

- Should the following irregularity be found during use, immediately switch off the power, disconnect the power supply plug from the AC outlet and contact your nearest Quest dealer. Make no further attempt to operate the unit in this condition as this may cause fire or electric shock.
 - If you detect smoke or a strange smell coming from the unit.
 - If water or any metallic object gets into the unit
 - If the unit falls, or the unit case breaks
 - If the power supply cord is damaged (exposure of the core, disconnection, etc.)
 - If it is malfunctioning (no tone sounds.)
- To prevent a fire or electric shock, never open nor remove the unit case as there are high voltage components inside the unit. Refer all servicing to your nearest Quest dealer.
- Do not place cups, bowls, or other containers of liquid or metallic objects on top of the unit. If they accidentally spill into the unit, this may cause a fire or electric shock.
- Do not insert nor drop metallic objects or flammable materials in the ventilation slots of the unit's cover, as this may result in fire or electric shock.

2



CAUTION

When Installing the Unit

- Never plug in nor remove the power supply plug with wet hands, as doing so may cause electric shock.
- When unplugging the power supply cord, be sure to grasp the power supply plug; never pull on the cord itself. Operating the unit with a damaged power supply cord may cause a fire or electric shock.
- When moving the unit, be sure to remove its power supply cord from the wall outlet. Moving the unit with the power cord connected to the outlet may cause damage to the power cord, resulting in fire or electric shock. When removing the power cord, be sure to hold its plug to pull.
- Do not block the ventilation slots in the unit's cover. Doing so may cause heat to build up inside the unit and result in fire.
- Avoid installing the unit in humid or dusty locations, in locations exposed to direct sunlight, near heaters, or in locations generating sooty smoke or steam as doing otherwise may result in fire or electric shock.

When the Unit is in Use

- Do not place heavy objects on the unit as this may cause it to fall or break which may result in personal injury and/or property damage. In addition, the object itself may fall off and cause injury and/or damage.
- Make sure that the volume control is set to minimum position before power is switched on. Loud noise produced at high volume when power is switched on can impair hearing.
- Do not operate the unit for an extended period of time with the sound distorting. This is an indication of a malfunction, which in turn can cause heat to generate and result in a fire.
- Contact your dealer as to cleaning. If dust is allowed to accumulate in the unit over a long period of time, a fire or damage to the unit may result.
- If dust accumulates on the power supply plug or in the wall AC outlet, a fire may result. Clean it periodically. In addition, insert the plug in the wall outlet securely.
- Switch off the power, and unplug the power supply plug from the AC outlet for safety purposes when cleaning or leaving the unit unused for 10 days or more. Doing otherwise may cause a fire or electric shock.



An all-pole mains switch with a contact separation of at least 3 mm in each pole shall be incorporated in the electrical installation of the building.

General Description

The 7 input channel mixer amplifier is designed for distributed paging and background music systems and in applications where music on hold (MOH) plus paging is required.

With 5 microphone/line inputs and 1 stereo input, the series mixer amplifiers will accommodate a variety of input sources including paging microphones, CD players, and digital music players. This 7 input channel mixer amplifier features muting and output options along with a special bridge in/out feature to allow combining of multiple amplifiers in applications without the need for external relays. VCA remote level control circuitry is included which may be assigned to the background music input or globally for the entire amplifier.

Features

- Rated output: 60w or 130w
- 24V DC interface
- Tape output
- Dual line output
- VCA level control
- 1 stereo Aux line input
- Pre out/power in patch
- VOX and remote mute
- Bridge I/O (Mix bus combining)
- Remote and VOX activated mute
- 5 Mic inputs with phantom power
- Zone 2 (MOH out) 1W @ 8 and 1.5V@ 600 .
- Constant voltage 70V and 100V line inputs and also with low impedance 4ohms speaker terminals
- The low cut filter is 6cBu/Octave@400HZ and bypasses the front panel bass control to allow for the use of paging horns

4

Front Panel Layout

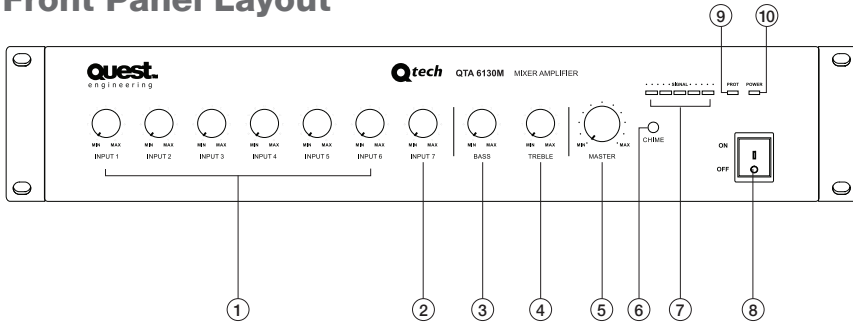

1. Input 1-7 Controls

The gain for input channels 1-7 are controlled by these rotary controls. The MASTER GAIN CONTROL must be turned up in addition to the input controls for audio to be present at the speaker terminals. Input 7 may be used as a dedicated input for paging via the PABX.

2. Tel Input

Telephone input volume control

3. Bass Control

The BASS CONTROL is a shelving type control which will boost or cut bass frequencies at 100Hz at the rate of +5dB.

4. Treble Control

The TREBLE CONTROL is a shelving type control which will boost or cut treble frequencies at 10kHz at the rate of +5dB.

5. Master Gain Control

The MASTER GAIN CONTROL will raise or lower all the input channels together.

6. Chime

Chime control

7. SIGNAL LED

This LED will assist you in setting gain structure into the amp. With a source connected to the amp and playing, turn up the channel gain control until this LED just starts to flash. Once all the sources connected are playing, the SIGNAL LED may be on solid. This condition is normal.

8. POWER SWITCH

This push on/push off switch applies power to the amplifier.

9. PROT LED

Indicates protection

10. POWER LED

This LED will illuminate when the amplifier is turned on.

5

Rear Panel Layout

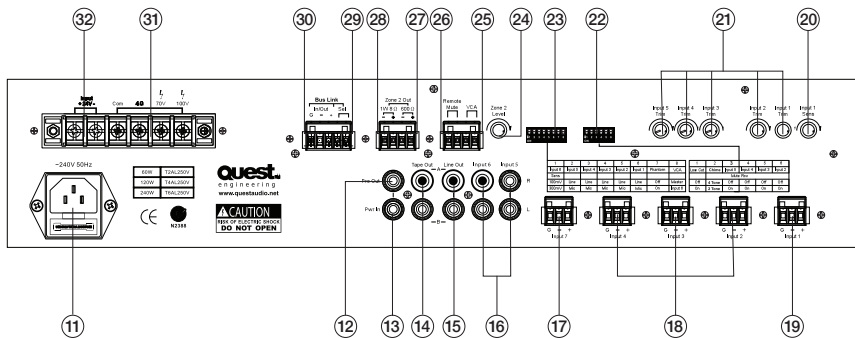

6

11. Power Socket

Connect the power cord to 240VAC only. Serious damage may result if accidentally connected to other line voltages.

12. Pre Out

The PRE OUT connector has Post tone control signals available to drive another power amp or external audio devices. Use in conjunction with the AMP IN connector, an effects loop can be created by connecting the PRE OUT jack to a device such as an equalizer then back out to the AMP IN connector. See the connection diagram in the setup section of this manual.

13. Pwr In

The AMP IN connector is useful for converting Mixer amp into a slave amp. When a line level signal is connected to this input, the internal connection between the preamp and internal power amp is broken. Mixer amp is now just a power amplifier, amplifying audio signals applied to this.

14. Tape Out A/B

Line level mono signals are available at this jack for connection to recording devices. The signal available here is PRE tone control and low cut filter and comes from the internal mix bus.

15. Line Out A/B

The LINE OUT connector is useful for providing unbalanced line level signals to another amplifier or other external devices. Prior to using this feature one must understand where the internal signal pick up point is so you can decide if it is correct for your application. We suggest you refer to the block diagram Mixer amp to have a complete understanding of the signal flow. **Note: The Following Conditions For LINE OUT**

- A. Pre Low Cut Filter
- B. Post Tone Controls (meaning the settings for the Bass and Treble controls affect this signals output). Note: Refer to Low Cut Filter Switch for complete understanding of the LCF feature.
- C. Post Amp In (meaning any signal that is inserted into the Pre AMP In jack will be present at the Line out).

16. Input 5/6

INPUT 5/6 consists of a pair of stereo line level inputs. Connect unbalanced audio outputs, such as CD player/MP3 player to input 6 only. Input 5 cannot be muted as this may be used for priority t devices such as an Alert/Avac controller.

17. Input 7 if used for Phone Paging

Tel inputs are balanced, line or mic level (Refer to Dipswitch Bank 1-8 for setting input sensitivity). Or wiring unbalanced inputs, tie (short) the (G) and (-) terminals together.

18. Inputs 2-4

Inputs 2-4 are balanced, line or mic level (Refer to Dipswitch Bank 1-8 for setting input sensitivity). For wiring unbalanced inputs, tie (short) the (G) and (-) terminals together.

19. Input 1

Balanced mic or line level signals connect to the (+) (-) and (G) terminals. Refer to the chart above "Multi Function Dipswitch" for the following setting. Dipswitch 6, labeled Input 1 must be set to the proper position for mic or Tel/Line level. If you are connecting an unbalanced line level input, tie (short) the (G) and (-) terminals together. An optional Input Isolation Transformer is available if a ground loop problem exists. Contact Quest for more details on the Input Isolation Transformer.

Note: Input 1 has priority over other channels. The sensitivity and threshold for the VOX send works in conjunction with the Input 1 Trim and the Input 1 Sens.

20. Input 1 Sens

This control adjusts how sensitive the mute send circuitry on INPUT 1 reacts. Setting the control fully counter-clockwise will lower the sensitivity, and a higher amplitude signal will be required at INPUT 1 to trigger the mute send circuits. Fully clockwise will raise the sensitivity of the mute circuits, where a lower amplitude signal will trigger a mute send. Careful calibration of this control may be required to fully utilize the mute circuits' capabilities. Adjustment of this control should occur after the input trim (19) for channel 1 is set.

21. Inputs 1-5 Trim

These variable controls allow fine tuning of the gain of INPUTS 1 - 5. There is 20dB of variable gain available. The trim only applies when the input is set to the "Mic" position on the dipswitch.

22. Dipswitch "A" Positions 1-6

Understanding the functionality of the dipswitches is key to getting the most out of the 60w/130w mixer amps. Whether the switch is in the "Up" or "Down" position is critical to the function of the amplifier.

Note: Mispositioning any of these switches may cause harm to the speakers or amplifier. We recommended all levels be turned down prior to making any changes. Pay close attention to the two assignment charts and manual for proper settings.

1	2	3	4	5	6
Low Cut	Input 6	Input 5	Input 4	Input 3	Input 2
Mute Rcv					
off	off	off	off	off	off
on	on	on	on	on	on

Dipswitch 1- LOW CUT

When in the "ON" position, frequencies below 400Hz are attenuated at the rate of 6dB per octave.

Note: The rotary bass control is bypassed when the LOW CUT filter is on. We suggest that when paging horns are connected to the Mixer amplifier, engage the LOW CUT filter to prevent the horns from operating below their cut off frequency. When "OFF", the amplifier operates full bandwidth.

Dipswitch 2-6 - MUTE RCV (RECEIVE)

When "ON", Input's 2-6 signals will be muted upon a signal from Input 1 (Refer to Number 11 Input 1 Sens), or a contact closure on the remote mute terminals (Refer to Number 15 Remote Mute).



23. Dipswitch "B" Positions 1-8

1	2	3	4	5	6	7	8
Input 6	Input 5	Input 4	Input 3	Input 2	Input 1	Phantom	VCA
Sens							
100mV	Line	Line	Line	Line	Line	off	Master
300mV	Mic	Mic	Mic	Mic	Mic	on	Input 6

Dipswitch 1

When set to the "100mV" position, the sensitivity of Input 6 is suitable for inputting Telephone Paging Signals. When set to the "300mV" position, the sensitivity of Input 6 is suitable for CD/DVD player outputs.

Dipswitch 2-5

When set to the "Line" position, input sensitivity is suitable for CD/DVD line level outputs. When set to the "Mic" position, sensitivity is suitable for microphone inputs.

Dipswitch 6

When set the "Tel/Line" position, Input 1 sensitivity is suitable for telephone paging and line level signals. When set to the "Mic" position, the sensitivity is set for microphone signals.

Dipswitch 7

When set to the "OFF" position, PHANTOM POWER is turned off on INPUTS 1-5. When set to the "ON" position, PHANTOM POWER (24VDC) is available on INPUTS 1-5 (mic position only).

Dipswitch 8

When set to the "Master" position, the VCA control port acts as an over all system remote volume control, adjusting all the input channels present on the master section mix bus up or down simultaneously. When set to the "Input 6" position, the VCA remote control port affects only the level of INPUT 6.

24. Zone 2 Level

This rotary control will vary the signal level at the Zone 2 output terminals. Fully counter-clockwise (0) is off; fully clockwise (21) is the maximum output level. The Zone 2 output gets its signal from INPUT 6, volume control.

25. VCA

Remote location of the level control can be accomplished via the VCA control port. You can control the overall level (Master) or just Input 6. This selection is made via Dipswitch "B" position #8. Connect the two leads from the optional remote volume control to these terminals. This remote level control is POST Master and Input 5 Level Controls. Set the system's maximum levels using the amplifier level controls and then use the remote VCA potentiometer as an attenuator from the maximum levels set. See the VCA setup section for instructions on wiring the potentiometer.

26. Remote Mute

The Remote Mute feature is useful when the background system needs to be muted from a remote location. When shorting the Remote Mute terminals together, (G) to (M), the assigned channels will be muted.

Note: Input 1 cannot be VOX or remote muted at anytime. Dipswitches 2-5 settings determine which inputs are to receive the Mute trigger. To trigger the mute it is common to use an external contact closure or switch on a microphone.

27. Zone 2 Output 600

The 600 1.5V (Zone 2 Out) output is typically connected to a PABX MUSIC ON HOLD port, also known as MOH. The ZONE 2 output gets its signal from the INPUT 6, volume control.

28. Zone 2 Output 1 Watt 8

The 8 Ohm 1W Zone 2 output can drive an external 8 Ohm speaker, and is taken Pre input 6 gain control. Use the 1W 8 Ohm terminals for connection to an external speaker.



29. Bridge Select

The "Bridge Select (Sel)" terminals are the access point to activate the "Bridge In / Out" feature. To activate the feature connect the two points together via an external contact closure. These two points must be connected to send or receive any signal. By connecting the Bridge In / Out terminals of the Mixer amp, a simple room combining system can be accomplished. If using a remote switch and closing it, the "Bridge Select (Sel)" will combine the amps as one, opening the switch will separate the amps.

Note: If combining 3 or 4 Mixer amps together the output level will have to be adjusted before and after Bridge Sel terminals are connected (shorted) together. We suggest utilizing the Remote Level control when using this feature.

31. SPEAKER TERMINALS

For loudspeaker connections, connect using the following information or proceed to the setup section for typical wiring diagrams.

COM - Speaker common or negative connection. 4 - Connect to direct coupled loudspeakers.

70V - Connect to transformer coupled, 70.7V loudspeakers with a total load impedance of no less than 41.6.

100V - Connect to transformer coupled, 100V loudspeakers with a total load impedance of no less than 83Ω

32. 24V DC interface

1	2	3	4	5	6	7	8
Input 6	Input 5	Input 4	Input 3	Input 2	Input 1	Phantom	VCA
Sens							
100mV	Line	Line	Line	Line	Tel/ Line	off	Master
300mV	Mic	Mic	Mic	Mic	Mic	on	Input 6

30. BRIDGE IN/OUT

Certain installations have the need to combine one or more Mixer amps together. These Mixer amps may operate different rooms of an install but have the need to share a page or music throughout the installation. These terminals provide a way to send and receive balanced line level signals from the internal mix bus of the Mixer amp. The "BRIDGE IN / OUT" feature is PRE Tone Controls and Low Cut Filter The Bridge In/Out feature allows you to send and receive a balanced signal. This is important for allowing longer distances between the mixers.

Note: This function should only be used with other Quest Sound mixers that have this feature. The Send and Receive signals are combined through the same terminals. To activate this feature, see number 19 Bridge Select



Connections

Speaker Connections

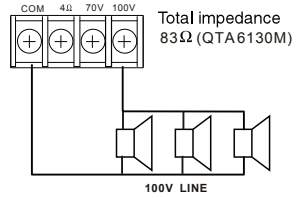
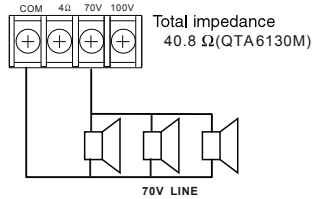
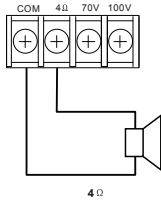

Notes:

- Both the 4Ω 70V/100V terminals cannot be used at the same time
- Impedances indicated in the figures represent the total speaker system (load) impedances



WARNING

Be sure to attach the supplied terminal cover after connection completion. Because high voltage is applied to the speaker terminals, never touch these terminals to avoid electric shocks.

10

Wiring The Vcc-10k Vca Potentiometer

Quest part number, VCC-10K, consists of a single gang wall plate with a pre-mounted 10K potentiometer and knob. This pot may be mounted on a plate to match the wall plates as nominated by the Architect. Use two conductor unshielded wire connecting the pot terminals to the terminals marked "VCA" on the back of the amp.

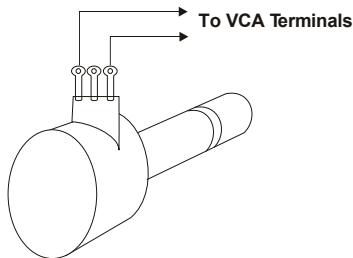

Security Covers Option

In order to prevent unauthorized operation of the 60w/130w mixer amplifiers, optional security covers are available which take the place of the front panel knobs.

After the 60w/130w mixer amp has been installed and is operating as desired, grasp the front panel knobs and pull straight out from the front panel. Replace the knobs with security covers, Quest part number VCC-5 available in quantities of 5.

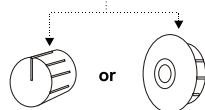
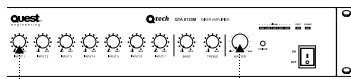

Panel Knob or Security Cover

Applications

Quick Start Examples

Example 1

System Paging, BGM, and MOH with Remote Master Level Control. This application has the paging microphone into INPUT 1, BGM (CD player) into Input 2, and a Message Repeater or MOH into Input 6. The Zone 2 Output is sent to the telephone system's MOH input port. A level control may be placed in another area such as a front desk to adjust the system's level without having to go the equipment room. When a page comes through Input 1, the BGM is muted allowing only paging to be heard through the main system. The MOH is not affected during the page.

- Connect a paging mic to INPUT 1. Set Dipswitch "B" #6, "Input 1" to the "Mic" position.

Note: The INPUT 1 Trim and Sens will need to be adjusted after all the settings and connections have been set.

Note: for 100V installations make the + connection to the 100V output

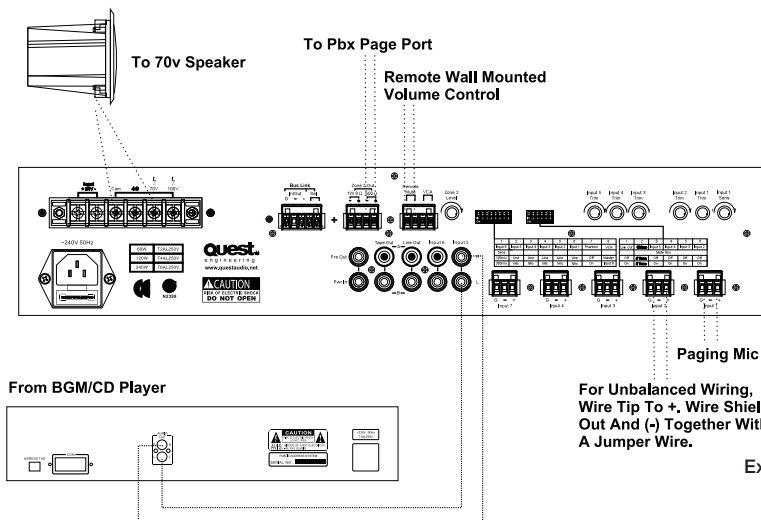

Example 1

Dipswitch Settings

- Dipswitch 1 - Off (Set To The Required Gain)
- Dipswitch 2 - Off (Not Affected)
- Dipswitch 3 - Off (Not Affected)
- Dipswitch 4 - Off (Not Affected)
- Dipswitch 5 - Off (Line)
- Dipswitch 6 - On (Mic)
- Dipswitch 7 - Depends On Mic Type
- Dipswitch 8 - Master

- Connect a BGM (CD) player to INPUT 2. Set Dipswitch "A" #6, "Mute Rcv" to the "ON" position. Connect a Message Repeater or MOH device to INPUT 6. Note: The input gain of this channel may need to be change for proper level balance. Dipswitch "B" #1, "Input 6" allows you to select between a 100mV or 300mV input sensitivity. Turn down channel 6 gain control on the front panel.
- Connect Zone 2 output to the MOH input on your telephone. Adjust the Zone 2 Output level as needed.
- Connect a wall mount volume control (Quest p/n AAVCC-10K) to the terminals marked "VCA". Set Dipswitch "B" #8, "VCA" to "Master".

11

Example 2 - Hotel Room Combining Using Two QTA 6000 Series

This example utilizes the combining feature of the Quest mixer amplifiers. The drawing below shows the equipment connections for two hotel ballrooms, separated by an operable wall. The hotel needs to be able to have the audio system operate as one large unit (wall open) or two discreet systems (wall closed). As indicated in the example, a BGM CD player is shared between the two amplifiers via a "Y" cable, connected to input 6 of each mixer amp.

A volume control and DPST switch (see drawing for clarity) controls the background music level and turns the music on or off in each room. For emergency evacuation purposes, a signal from the hotel's fire alarm system is connected to channel 1 of both amplifiers, with the mute sensitivity adjusted as needed. All other channels are set for mute receive and will mute when the siren tone is present on channel 1.

The Bridge terminals of both amplifiers are connected together, through a DPST switch that makes (combines) or breaks (separates) the Bridge connections between the amplifiers. When the switch is closed, any audio signal into either amp will be present at both amplifiers' speaker outputs.

Dipswitch Settings

- Dipswitch "A" 1-6 2-6 - On
- Dipswitch "B" 1-8
- Dipswitch 1 - (Set To The Required Gain)
- Dipswitch 2 - "Mic"
- Dipswitch 3 - "Mic"
- Dipswitch 4 - "Mic"

Note: for 100V installations make the + connection to the 100V output

70V Speaker Ballroom ...

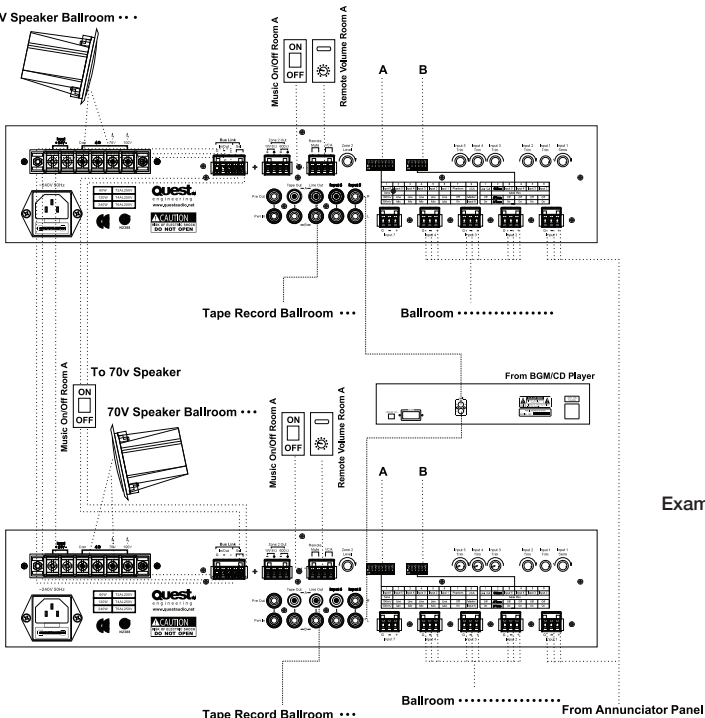

Example 2

12

Example 3 - Small House of Worship

The diagram below shows a typical small House of Worship audio system. This system utilizes four microphones, one for the Pulpit and three on the choir. A Master volume control (Quest VC - 10K) is connected to the "VCA" terminals for overall level control. For background music, a CD player's audio outputs are connected to the "VCA" terminals for overall level control. For background music, a CD player's audio outputs are connected to the Tape Out jacks, and a recording device (cassette recorder or computer's audio input) is connected to the Tape Out jacks. For system tuning, a 1/3rd octave graphic EQ is connected to the Pre Out/ Pwr In jacks. For the "cry room" an 8 Ohm speaker is connected to the Zone 2 "1W 8" output.

Dipswitch Settings

Dipswitch "A" 1-6 All Off

Dipswitch "B" 1-8

Switch 1 - 300mV

Switch 2 - "Not Used"

Switch 3 - "Mic"

Switch 4 - "Mic"

Switch 5 - "Mic"

Switch 6 - "Mic"

Switch 7 - Will depend on type of microphones used

Switch 8 - Master

Note: for 100V installations make the + connection to the 100V output

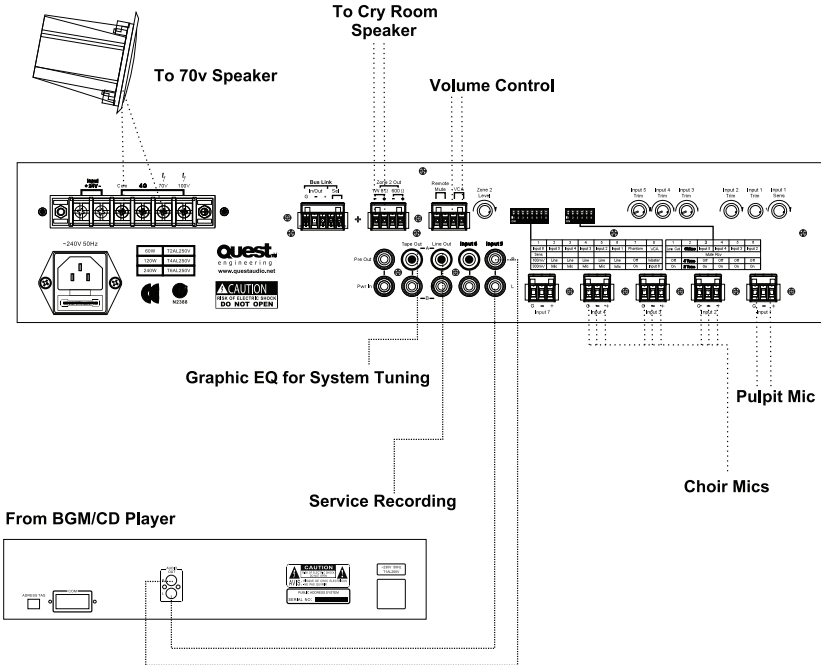

13

Example 3

Block Diagram

14

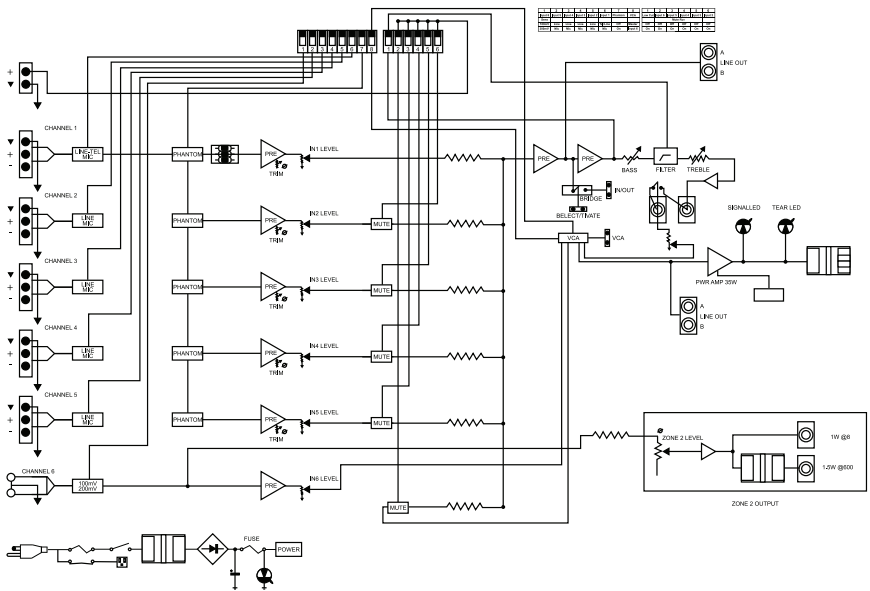

Specifications

Mixer Amplifier

Type	Mixer Amplifier	
Model	QTA-6060M	QTA-6130M
Rated Output Power	60W	130W
Transformer Outputs	4 Ω ,70V/100V	
Frequency Response	50Hz~16KHz \pm 2dB	
Distortion	<1% at rated power (1KHz)	
Sensitivity	Input 1 : Line/Tel 316mV(-10dBV) 10Kohm (600 Ω w optional/ transformer)	
	Mic :316mV~3.16mV (-50dBV~-70dBV)	
	Input 1-5 : Line 316mV(-10dBV) 10Kohm Mic 316mV~3.16mV (-50dBV~-70dBV)	
	Input 6 : Line 300mV/100mV(-10dBV/-20dBV) Selectable	
Outputs	Main: Transformer coupled, balanced, 8 Ω , 25V, and 70V	
	Zone 2~8 Ω Unbalanced 1W	
	Zone 2~600 Ω Balanced 1.5V	
Signal to Noise Ratio	Mic >55dB	
	Line >55dB	
	Telephone >75dB	
Tone Controls : Bass	\pm 10dB @ 100Hz	
Tone Controls : Treble	\pm 10dB @ 10kH	
Indicators	Power, signal, peak	
Power Requirements	~240V/50Hz,24V DC (Optional)	
Power Consumption	100W	200W
Dimensions (mm)	484X300X88	484X300X88
Net Weight	13kg	15kg
Gross Weight	14.2kg	16.2kg



Dimensional Diagram

UNIT: mm

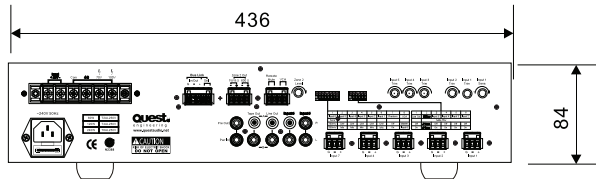
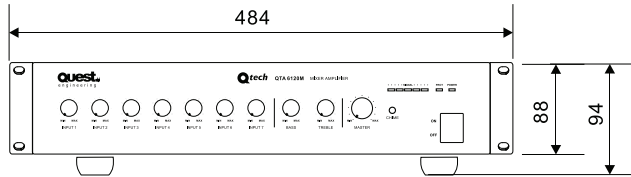

16

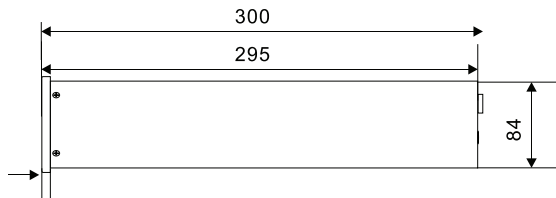

Keep all the unit's sides over 10cm away from objects that may obstruct air flow to prevent the unit's internal temperature rising.

UNIT: mm

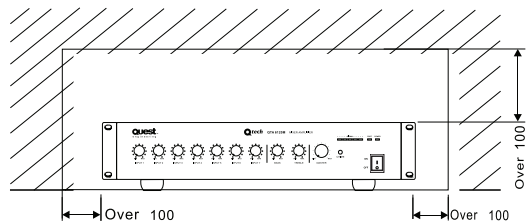

Technical Notes

Constant Voltage Distributed Speaker Systems Demystified

In a typical paging and background music speaker installation, quantity loudspeakers are placed across a single amplifier in a parallel wiring configuration (see Fig 1.).

Each ceiling speaker will contain a small transformer and you will notice that the connection block near the transformer will have a common terminal (C or earth), and a number of wattage terminals.

Connect the wattage setting terminal for the desired acoustic output (volume) level you need from each individual speaker.

This will be a 100V setting in Europe and most of Asia and 70V in the USA. (See the explanation below)

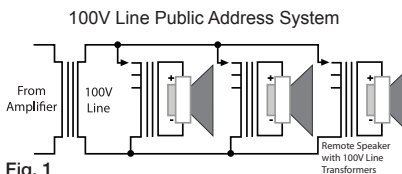

Fig. 1

Often some speakers need to be set at different volume output levels, and the calculations involved in determining the actual load impedance at the amplifier's output can be quite involved but there is a simple technique for not overloading the amplifier

As for the amplifiers, there are two common standards, 100 Volt line in Europe and Asia and 70 Volt line on the American continent.

For the purpose of simple calculations, we will use the European standard for this exercise.

On the rear of a 70/100V amplifier you will find an output terminal strip (see Fig 2). This terminal strip will contain a number of +

voltage outputs (70V 100V) and a terminal at one end for the negative return wire (COM).

A low impedance terminal will be for 8-ohm speaker installations and is under no circumstances to be connected to a transformer type speaker system.

Installation practice

Step 1. Take a piece of figure-8 cable, connect the stripe/coloured wire to the 100V terminal and the uncoloured wire to the COM on the amplifier terminal strip.

Step 2. Connect the other end of the wire (uncoloured) to the Com/EARTH connection on the ceiling speaker transformer and the other + (stripe) wire to the required voltage tapping.

Step 3. Take a second piece of figure-8 cable and connect the plain wire to the parallel COM connection and the other + (stripe) wire to the parallel output from the transformer terminal block and connect it in the same way to the next ceiling speaker.

Step 4. Continue this process until all the ceiling speakers are connected in a parallel connection with all the COM connections and all the wattage connections following a parallel connection.

Common problems with ceiling speaker installations

System is distorting. Check for the following causes:

1. Too many speakers set to too high a power tapping for the power of the amplifier
Solution: Calculate the total power draw and re connect the speakers to a lower the wattage tapping. (See below)

Some cheap ceiling speakers have incorrect tapping labels. A 10 watt speaker may really be drawing 15 or 20 watts. The only way to test this is with an impedance meter on a single speaker. A

15% discrepancy can mean that a 100 watt system will only be able to power 7 or 8 x10 watt speakers safely. Be aware of this booby trap. Always plan to have 20% more power than you think you will need.

2. Incorrect output connection: If you accidentally connect your terminal strip on the amplifier to the 8 ohm output instead of the 100/70V line, you will have distortion and risk damaging the amplifier..
3. Short circuits and no circuits: Check that your wiring has not been accidentally cut, miss-connected or generally damaged in the course of installation. This can be common with building sites with multiple trades people installing equipment into the same ceiling cavities as the audio system.

How to calculate the correct number of speakers and what wattage connection for a given amplifier power.

18

If you connect too many speakers to an amplifier you will have distortion, overheating of the amplifier and generally poor performance. The problem is not really “too many speakers”, it is more a problem of “too much wattage draw exceeding the output capability of an amplifier. A similar problem would be trying to draw 2,000 watts from a 1,000 watt generator. Sooner or later.... Expect a system failure.

Let us take a 100 watt amplifier. If you have 20 speakers and you set them at the 5 watt taping, you will have a total 100 watt draw which is the maximum output of the amplifier. This is correct in theory but in practice you will be safer connecting 18 speakers, not 20. The reason is that most ceiling speakers draw more than their claimed wattage.

The alternative would be to connect the speakers to the 4 watt transformer terminal giving you a theoretical total draw of 80 watts and thus, plenty of “headroom”. One watt difference is not very noticeable as far as output sound pressure level in concerned.

A system that does not distort will give much clearer voice reproduction than a louder system that is distorting or loosing the sibilant frequencies.

There is a formula for testing the potential power of the system by measuring the impedance of each speaker and then adding all the figures to a total impedance, which is then compared to the amplifier's expected impedance/power figures. The quick way is to just add up all the wattages and then give yourself 10-20% headroom by reducing the number of speakers per amplifier or lowering the wattages slightly.

For the benefit of those who want to calculate the power of the system with a formula. See below:

Determining power by calculating total impedance

The alternative to counting the speaker taping watts is to calculate the total impedance of the line, which will also indicate the wattage necessary to drive the system correctly.

The computational formula is voltage squared divided by impedance:

Power = Voltage² / Impedance.

When the speaker line reaches its top voltage of 70 Volts, the formula is:

Power = 5000 / Impedance (because 70 squared equals 5000).

To measure impedance a dedicated meter is required. These use a 1k frequency to send an alternating current through the transformer(s). The resulting figure indicated by the meter's dial can be cross referenced with the meter's impedance chart to see what value should be expected and the power that will be required.

High impedance of speakers and output calculation table for 100Volt systems

Output	Impedance	Output	Impedance	Output	Impedance
0.1W	100KΩ	10W	1KΩ	40W	250Ω
0.5W	20KΩ	15W	667Ω	50W	200Ω
1W	10KΩ	20W	500Ω	75W	133Ω
2W	5KΩ	25W	400Ω	100W	100Ω
3W	3.33KΩ	30W	333Ω	150W	66.7Ω
5W	2KΩ	35W	286Ω	200W	50Ω

(100V plan) $P = E \times E / Z = 100 \times 100 / Z = 10,000 / Z$

P: Power(W), Z : Impedance (Ω), E : 100V(Designed voltage of a general-use amplifier)





www.questengineering.com.au

Quest Engineering Pty Ltd

130 -140 Melrose Dr, Tullamarine VIC 3043 Australia
Phone +61 (0) 3 8373 6868 | Fax +61 (0) 3 8373 6899